

HFA08PB120

Ultrafast, Soft Recovery Diode

Features

- Ultrafast Recovery
- Ultrasoft Recovery
- Very Low I_{RRM}
- Very Low Q_{rr}
- Guaranteed Avalanche
- Specified at Operating Conditions

Benefits

- Reduced RFI and EMI
- Reduced Power Loss in Diode and Switching Transistor
- Higher Frequency Operation
- Reduced Snubbing
- Reduced Parts Count

Description

International Rectifier's HFA08PB120 is a state of the art center tap ultra fast recovery diode. Employing the latest in epitaxial construction and advanced processing techniques it features a superb combination of characteristics which result in performance which is unsurpassed by any rectifier previously available. With basic ratings of 1200 volts and 8 amps continuous current, the HFA08PB120 is especially well suited for use as the companion diode for IGBTs and MOSFETs. In addition to ultra fast recovery time, the HEXFRED product line features extremely low values of peak recovery current (I_{RRM}) and does not exhibit any tendency to "snap-off" during the t_b portion of recovery. The HEXFRED features combine to offer designers a rectifier with lower noise and significantly lower switching losses in both the diode and the switching transistor. These HEXFRED advantages can help to significantly reduce snubbing, component count and heatsink sizes. The HEXFRED HFA08PB120 is ideally suited for applications in power supplies and power conversion systems (such as inverters), motor drives, and many other similar applications where high speed, high efficiency is needed.

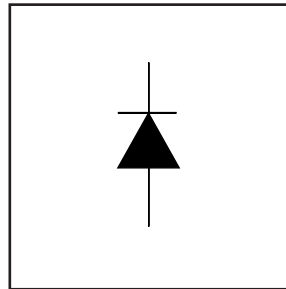

$V_R = 1200V$
$V_F(\text{typ.})^* = 2.4V$
$I_{F(AV)} = 8.0A$
$Q_{rr}(\text{typ.}) = 140nC$
$I_{RRM}(\text{typ.}) = 4.5A$
$t_{rr}(\text{typ.}) = 28ns$
$di_{(rec)}/dt(\text{typ.})^* = 85A/\mu s$

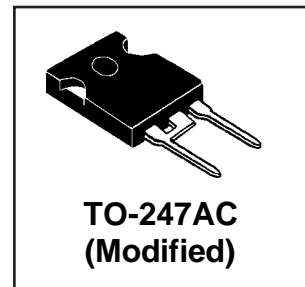

Absolute Maximum Ratings

	Parameter	Max.	Units
V_R	Cathode-to-Anode Voltage	1200	V
$I_F @ T_C = 25^\circ C$	Continuous Forward Current		A
$I_F @ T_C = 100^\circ C$	Continuous Forward Current	8.0	
I_{FSM}	Single Pulse Forward Current	130	
I_{FRM}	Maximum Repetitive Forward Current	32	
$I_{AS} \textcircled{1}$	Maximum Single Pulse Avalanche Current	8.0	
$P_D @ T_C = 25^\circ C$	Maximum Power Dissipation	73.5	W
$P_D @ T_C = 100^\circ C$	Maximum Power Dissipation	29	
T_J	Operating Junction and	-55 to +150	$^\circ C$
T_{STG}	Storage Temperature Range		

* $125^\circ C$

HFA08PB120

International
IOR Rectifier

Electrical Characteristics @ $T_J = 25^\circ\text{C}$ (unless otherwise specified)

	Parameter	Min.	Typ.	Max.	Units	Test Conditions
V_{BR}	Cathode Anode Breakdown Voltage	1200	—	—	V	$I_R = 100\mu\text{A}$
V_{FM}	Max Forward Voltage	—	2.6	3.3	V	$I_F = 8.0\text{A}$ $I_F = 16\text{A}$ $I_F = 8.0\text{A}, T_J = 125^\circ\text{C}$
		—	3.4	4.3		
		—	2.4	3.1		
I_{RM}	Max Reverse Leakage Current	—	0.31	10	μA	$V_R = V_R \text{ Rated}$ $T_J = 125^\circ\text{C}, V_R = 0.8 \times V_R \text{ Rated}$
		—	135	1000		
C_T	Junction Capacitance	—	11	20	pF	$V_R = 200\text{V}$ See Fig. 3
L_S	Series Inductance	—	8.0	—	nH	Measured lead to lead 5mm from package body

Dynamic Recovery Characteristics @ $T_J = 25^\circ\text{C}$ (unless otherwise specified)

	Parameter	Min.	Typ.	Max.	Units	Test Conditions
t_{rr}	Reverse Recovery Time	—	28	—	ns	$I_F = 1.0\text{A}, di/dt = 200\text{A}/\mu\text{s}, V_R = 30\text{V}$ $T_J = 25^\circ\text{C}$
t_{rr1}	See Fig. 5, 10	—	63	95		
t_{rr2}		—	106	160	A	$I_F = 8.0\text{A}$ $V_R = 200\text{V}$
I_{RRM1}	Peak Recovery Current	—	4.5	8.0		
I_{RRM2}	See Fig. 6	—	6.2	11	nC	$T_J = 25^\circ\text{C}$ $T_J = 125^\circ\text{C}$
Q_{rr1}	Reverse Recovery Charge	—	140	380		
Q_{rr2}	See Fig. 7	—	335	880	A/ μs	$di/dt = 200\text{A}/\mu\text{s}$ $T_J = 25^\circ\text{C}$ $T_J = 125^\circ\text{C}$
$di_{(rec)M}/dt1$	Peak Rate of Fall of Recovery Current	—	133	—		
$di_{(rec)M}/dt2$	During t_b See Fig. 8	—	85	—		

Thermal - Mechanical Characteristics

	Parameter	Min.	Typ.	Max.	Units
$T_{lead}^{(2)}$	Lead Temperature	—	—	300	$^\circ\text{C}$
$R_{\theta JC}$	Thermal Resistance, Junction to Case	—	—	1.7	K/W
$R_{\theta JA}^{(3)}$	Thermal Resistance, Junction to Ambient	—	—	40	
$R_{\theta CS}^{(4)}$	Thermal Resistance, Case to Heat Sink	—	0.25	—	
Wt	Weight	—	6.0	—	g
		—	0.21	—	(oz)
	Mounting Torque	6.0	—	12	Kg-cm
		5.0	—	10	lbf-in

- ① $L=100\mu\text{H}$, duty cycle limited by max T_J
- ② 0.063 in. from Case (1.6mm) for 10 sec
- ③ Typical Socket Mount
- ④ Mounting Surface, Flat, Smooth and Greased

Instantaneous Forward Current - I_F (A)

Fig. 1 - Maximum Forward Voltage Drop vs. Instantaneous Forward Current

Reverse Current - I_R (μ A)

Fig. 2 - Typical Reverse Current vs. Reverse Voltage

Junction Capacitance - C_T (pF)

Fig. 3 - Typical Junction Capacitance vs. Reverse Voltage

Fig. 4 - Maximum Thermal Impedance Z_{thjc} Characteristics

t_{rr} - (nC)

I_{rr} - (A)

Fig. 5 - Typical Reverse Recovery vs. di_f/dt ,
(per Leg)

Fig. 6 - Typical Recovery Current vs. di_f/dt ,
(per Leg)

Q_{rr} - (nC)

$di_{(rec)M}/dt$ - (A / μ s)

Fig. 7 - Typical Stored Charge vs. di_f/dt ,
(per Leg)

Fig. 8 - Typical $di_{(rec)M}/dt$ vs. di_f/dt ,
(per Leg)

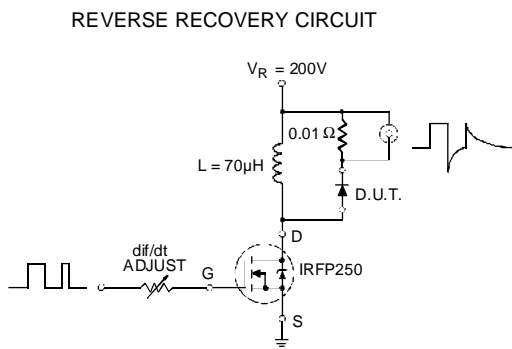

Fig. 9 - Reverse Recovery Parameter Test Circuit

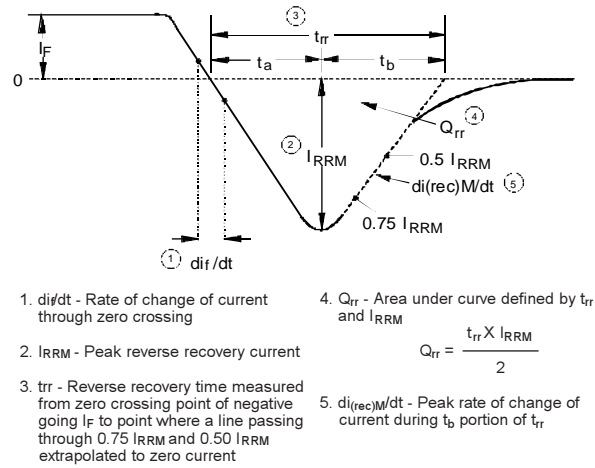

Fig. 10 - Reverse Recovery Waveform and Definitions

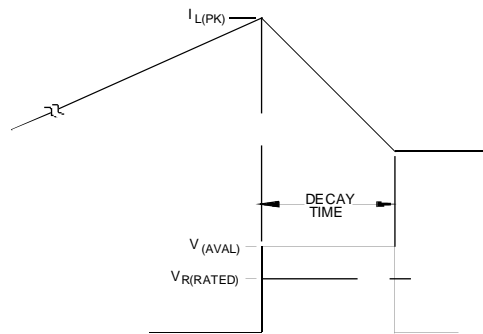
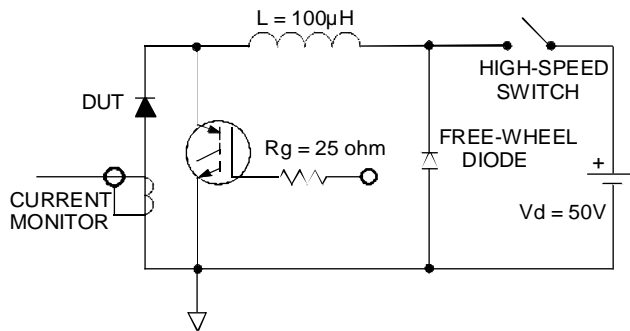
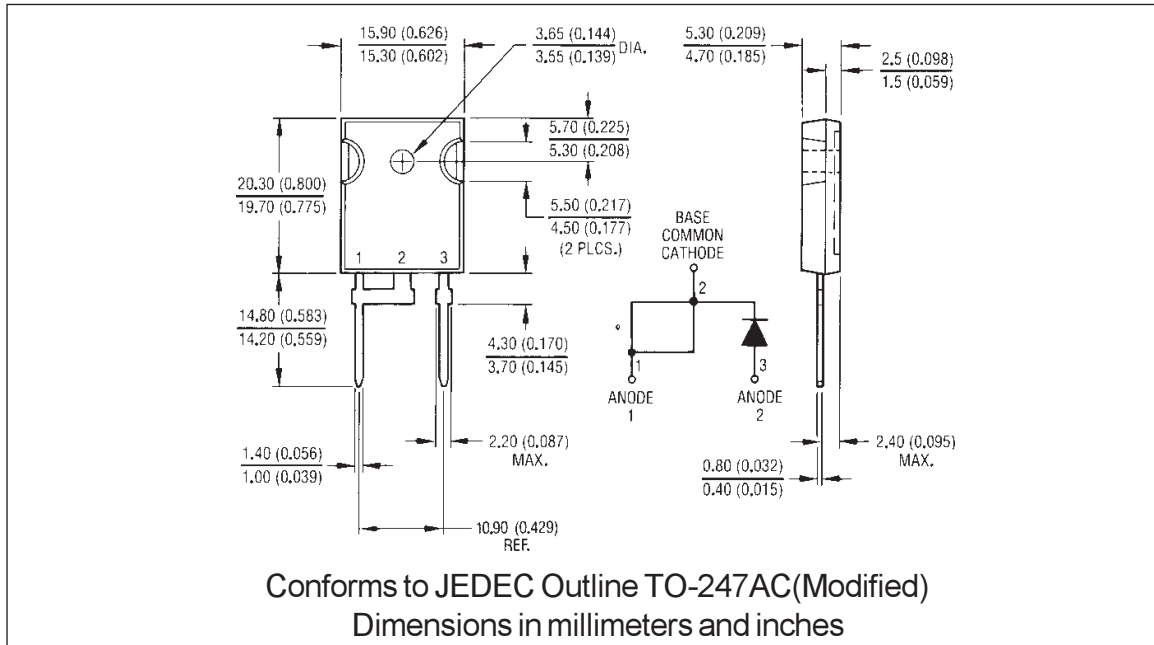

Fig. 11 - Avalanche Test Circuit and Waveforms

HFA08PB120

International
IR Rectifier



International
IR Rectifier

WORLD HEADQUARTERS: 233 Kansas St., El Segundo, California 90245, Tel: (310) 322 3331

EUROPEAN HEADQUARTERS: Hurst Green, Oxted, Surrey RH8 9BB, UK Tel: ++ 44 1883 732020

IR CANADA: 7321 Victoria Park Ave., Suite 201, Markham, Ontario L3R 2Z8, Tel: (905) 475 1897

IR GERMANY: Saalburgstrasse 157, 61350 Bad Homburg Tel: ++ 49 6172 96590

IR ITALY: Via Liguria 49, 10071 Borgaro, Torino Tel: ++ 39 11 451 0111

IR FAR EAST: K&H Bldg., 2F, 30-4 Nishi-Ikebukuro 3-Chome, Toshima-Ku, Tokyo Japan 171 Tel: 81 3 3983 0086

IR SOUTHEAST ASIA: 315 Outram Road, #10-02 Tan Boon Liat Building, Singapore 0316 Tel: 65 221 8371

<http://www.irf.com/>

Data and specifications subject to change without notice.

5/97